















USER MANUAL
MS6111
Stand-on Floor Scale



Please keep the instruction manual at hand all the time for future reference.

Explanation of Graphic Symbols on Label/Packaging

	<p>Caution, consult accompanying documents before use</p>		<p>Separate collection for waste of electrical and electronic equipment, in accordance with Directive 2002/96/EC</p>
	<p>Manufacturer of medical device</p>		<p>Manufacturing year of medical device</p>
	<p>Carefully read user manual before installation and usage, and follow instructions for use.</p>		<p>Medical electrical equipment with Type B applied part</p>
	<p>Device catalogue number</p>		<p>Authorized representative in the European Community</p>
	<p>Manufacturer's batch or lot number</p>		<p>Device is a medical device</p>
	<p>Serial number</p>		<p>Unique Device Identifier</p>
		<p>Device conforms to 93/42/EEC as amended by 2007/47/EC Medical Device Directive. Four digit number refers to Notified Body.</p>	

Copyright Notice

Charder Electronic Co., Ltd.

No.103, Guozhong Rd., Dali Dist., Taichung City 41262 Taiwan

Tel: +886-4-2406 3766

Fax: +886-4-2406 5612

Website: www.chardermedical.com E-mail: info_cec@charder.com.tw

Copyright© Charder Electronic Co., Ltd. All rights reserved.

This user manual is protected by international copyright law. All content is licensed, and usage is subject to written authorization from Charder Electronic Co., Ltd. (hereinafter Charder) Charder is not liable for any damage caused by a failure to adhere to requirements stated in this manual. Charder reserves the right to correct misprints in the manual without prior notice, and modify the exterior of the device for quality purposes without customer consent.



Charder Electronic Co., Ltd.
No. 103, Guozhong Rd., Dali Dist.,
Taichung City, 41262 Taiwan

CONTENTS

I. Safety Notes	5
A. General Information	5
B. EMC Guidance and Manufacturer's Declaration	8
II. Installation	12
A. Assembly	12
B. Inserting Batteries	12
C. Using Adapter	12
III. Indicator	13
A. Indicator and Key Functions	13
B. Display layout.....	13
IV. Using Device	14
A. Basic Operation	14
B. Hold	14
C. Tare	15
D. Body Mass Index (BMI)	15
V. Device Setup	16
VI. Wireless Connection	17
VII. Troubleshooting	18
VIII. Product Specifications	20
IX. Declaration of Conformity	24



I. Safety Notes

A. General Information

Thank you for choosing this Charder Medical device. It is designed to be easy and straightforward to operate, but if you encounter any problems not addressed in this manual, please contact your local Charder service partner.

Before beginning operation of the device, please read this user manual carefully, and keep it in a safe place for reference. It contains important instructions regarding installation, proper usage, and maintenance.

Intended Use

This device is intended to measure the weight of subjects who can stand unassisted, for diagnosis of weight-related issues by professionals.

General Handling

- Device should be placed on stable, flat, solid, non-slippery surface.
- Usage on soft surfaces (ex: carpet) may result in inaccurate results.
- Ensure all parts are properly locked and tightened before operating the device.
- Device is intended to measure one subject at a time.

Safety Instructions

- Batteries should be kept away from children. If swallowed, promptly seek medical assistance.
- Expected service life: 5 years.
- Always comply with appropriate regulations when using electrical components under increased safety requirements.
- Ensure voltage marked on power supply matches mains power supply.
- The device is intended for indoor use only.
- Observe permissible ambient temperatures for use

Environmental

- All batteries contain toxic compounds; batteries should be disposed of via designated competent organizations. Batteries should not be incinerated.

Cleaning

- Device surface should be cleaned using alcohol-based wipes. Corrosive cleansing liquids should not be used. Pressure-washers

should not be used.

- Do not use large amounts of water when cleaning the device, as it may cause damage to the internal electronics.
- Always disconnect device from mains power before cleaning.

Maintenance

- Device does not require routine maintenance. However, regular checking of accuracy is recommended; frequency to be determined by level of use and state of device. If results are inaccurate, please contact local distributor.

Warranty/Liability

- The period of warranty shall be eighteen (18) months, beginning on the date of purchase. Please retain your receipt as proof of purchase.
- No responsibility shall be accepted for damage caused through any of the following reasons: unsuitable or improper storage or use, incorrect installation or commissioning by the owner or third parties, natural wear and tear, changes or modifications, incorrect or negligent handling, chemical, electrochemical, or electrical interference.
- All maintenance, technical inspections, and repairs should be conducted by an authorized Charder service partner, using original Charder accessories and spare parts. Charder is not liable for any damages arising from improper maintenance or usage.

Disposal

- This product is not to be treated as regular household waste, but should be taken to a designated collection points for electronics. Further information should be provided by local waste disposal authorities.



Warning

- Only the original adapter should be used with the device. Using an adapter other than the one provided by Charder may cause malfunction.
- Do not touch the power supply with wet hands.
- Do not crimp the power cable, and avoid sharp edges.
- Do not overload extension cables connected to the device.
- Route cables carefully, to avoid tripping.
- Keep device away from liquids.
- Do not remove the plug by yanking on the cable.
- Use only a correctly wired (100-240VAC) outlet, and do not use a

multiple outlet extension cable.

- Do not under any circumstances dismantle or alter the device, as this could result in electric shock or injury as well as adversely affect the precision of measurements.
- Do not place the device in direct sunlight, or in close proximity to an intense heat source. Excessively high temperatures may damage the internal electronics.

Incident Reporting

- Any serious incident that has occurred in relation to the device should be reported to the manufacturer, EU representative (if device is used in EU member state), and competent authority of user/subject's member state.

B. EMC Guidance and Manufacturer's Declaration

Guidance and manufacturer's declaration-electromagnetic emissions		
The MS6111 Stand-on Floor Scale is intended for use in the electromagnetic environment specified below. The customer or the user of the device should assure that it is used in such an environment.		
Emission test	Compliance	Electromagnetic environment-guidance
RF emissions CISPR 11	Group 1	The device uses RF energy only for its internal function. Therefore, its RF emissions are very low and are not likely to cause any interference in nearby electronic equipment.
RF emissions CISPR 11	Class B	The device is suitable for use in all establishments, including domestic establishments and those directly connected to the public low-voltage power supply network that supplies buildings used for domestic purposes.
Harmonic emissions IEC 61000-3-2	Class A	
Voltage fluctuations /flicker emissions IEC 61000-3-3	Compliance	

Guidance and manufacturer's declaration-electromagnetic immunity			
The MS6111 Stand-on Floor Scale is intended for use in the electromagnetic environment specified below. The customer or the user of the device should assure that it is used in such an environment.			
Immunity test	IEC 60601 test level	Compliance level	Electromagnetic environment-guidance
Electrostatic discharge(ESD) IEC 61000-4-2	<u>± 8 kV contact</u> <u>± 2 kV, ± 4 kV,</u> <u>± 8 kV, ± 15 kV</u> <u>air</u>	<u>± 8 kV contact</u> <u>± 2 kV, ± 4 kV,</u> <u>± 8 kV, ± 15 kV</u> <u>air</u>	Floors should be wood, concrete or ceramic tile. If floors are covered with synthetic material, the relative humidity should be at least 30%
Electrical fast transient/burst IEC 61000-4-4	± 2kV for power supply lines + 1kV for input/output lines	+ 2kV for power supply lines + 1kV for input/output lines	Mains power quality should be that of a typical commercial or hospital environment.

Surge IEC 61000-4-5	± 1kV line(s) to line(s) ± 2kV line(s) to earth	+ 1kV line(s) to line(s) + 2kV line(s) to earth	Mains power quality should be that of a typical commercial or hospital environment.
Voltage Dips, short interruptions and voltage variations on power supply input lines IEC 61000-4-11	<u>0% UT for 0,5 cycle</u> <u>0% UT for 1 cycle</u> <u>70% UT(30% dip in UT) for 25 cycles</u> <u>0% UT for 5 s</u>	<u>0% UT for 0,5 cycle</u> <u>0% UT for 1 cycle</u> <u>70% UT(30% dip in UT) for 25 cycles</u> <u>0% UT for 5 s</u>	Mains power quality should be that of a typical commercial or hospital environment. If the user of the device requires continued operation during power mains interruptions, it is recommended that the device be powered from an uninterruptible power supply or a battery.
Power frequency(50/60 Hz) magnetic field IEC 61000-4-8	<u>30 A/m</u>	<u>30 A/m</u>	The device power frequency magnetic fields should be at levels characteristic of a typical location in a typical commercial or hospital environment.

NOTE UT is the a.c. mains voltage prior to application of the test level.

Guidance and manufacturer's declaration-electromagnetic immunity

The MS6111 Stand-on Floor Scale is intended for use in the electromagnetic environment specified below. The customer or the user of the device should assure that is used in such an environment.

Immunity test	IEC 60601 test level	Compliance level	Electromagnetic environment-guidance
Conducted RF IEC 61000-4-6	3 Vrms 150 KHz to 80 MHz	3 Vrms 150 KHz to 80 MHz	Portable and mobile RF communications equipment should be used no closer to any part of the device including cables, than the recommended separation distance calculated from the equation applicable to the frequency of the transmitter. Recommended separation distance: $d = 1,2 \sqrt{P}$
Radiated RF IEC 61000-4-3	<u>6 V in ISM bands between 0,15 MHz and 80 MHz</u> <u>80 % AM at 1 kHz</u> 3 V/m 80MHz to 2,7 GHz	<u>6 V in ISM bands between 0,15 MHz and 80 MHz</u> <u>80 % AM at 1 kHz</u> 3 V/m <u>80MHz to 2,7 GHz</u>	

			<p> $d = 1,2 \sqrt{P}$ 80MHz to 800 MHz $d = 2,3 \sqrt{P}$ 800MHz to 2,5 GHz </p> <p>Where P is the maximum output power rating of the transmitter in watts (W) according to the transmitter manufacturer and d is the recommended separation distance in metres (m).</p> <p>Field strengths from fixed RF transmitters, as determined by an electromagnetic site survey^a, should be less than the compliance level in each frequency range^b.</p> <p>Interference may occur in the vicinity of equipment marked with the following symbol:</p> 
--	--	--	---

NOTE1 At 80 MHz and 800 MHz, the higher frequency range applies.

NOTE2 These guidelines may not apply in all situations. Electromagnetic propagation is affected by absorption and reflection from structures, objects and people.

- a Field strengths from fixed transmitters, such as base stations for radio (cellular/cordless) telephones and land mobile radios, amateur radio, AM and FM radio broadcast and TV broadcast cannot be predicted theoretically with accuracy. To assess the electromagnetic environment due to fixed RF transmitters, an electromagnetic site survey should be considered. If the measured field strength in the location in which the device is used exceeds the applicable RF compliance level above, the device should be observed to verify normal operation. If abnormal performance is observed, additional measures may be necessary, such as re-orienting or relocating the device.
- b Over the frequency range 150 kHz to 80 MHz, field strengths should be less than 3 V/m.

Recommended separation distance between portable and mobile RF communications equipment and the MS6111 Stand-on Floor Scale

The device is intended for use in an electromagnetic environment in which radiated RF disturbances are controlled. The customer or the user of the device can help prevent electromagnetic interference by maintaining a minimum distance between portable and mobile RF communications equipment (transmitters) and the device as recommended below, according to the maximum output power of the communications equipment.

Rated maximum output power of transmitter W	Separation distance according to frequency of transmitter m		
	150 kHz to 80 MHz $d = 1,2\sqrt{P}$	80 MHz to 800 MHz $d = 1,2\sqrt{P}$	800 MHz to 2,5 GHz $d = 2,3\sqrt{P}$
0,01	0,12	0,12	0,23
0,1	0,38	0,38	0,73
1	1,2	1,2	2,3
10	3,8	3,8	7,3
100	12	12	23

For transmitters rated at a maximum output power not listed above, the recommended separation distance d in metres (m) can be estimated using the equation applicable to the frequency of the transmitter, where p is the maximum output power rating of the transmitter in watts (W) according to the transmitter manufacturer.

NOTE1 At 80 MHz and 800 MHz, the separation distance for the higher frequency range applies.

NOTE2 These guidelines may not apply in all situations. Electromagnetic propagation is affected by absorption and reflection from structures, objects and people.

II. Installation

A. Assembly

Device does not require assembly, and can be used once power is supplied.

B. Inserting Batteries

Insert 4 AA batteries into compartment

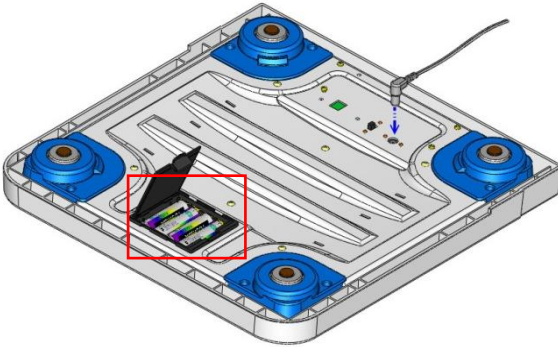

2. Turn on power to confirm that battery is correctly installed.

C. Using Adapter

1. Connect adapter to device before connecting to mains power supply

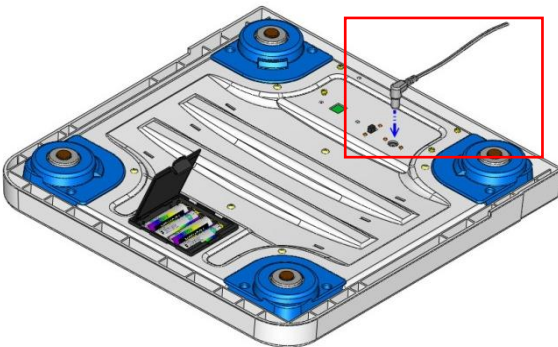

2. Disconnect adapter from mains power supply before unplugging adapter pin from device.

III. Indicator

A. Indicator and Key Functions

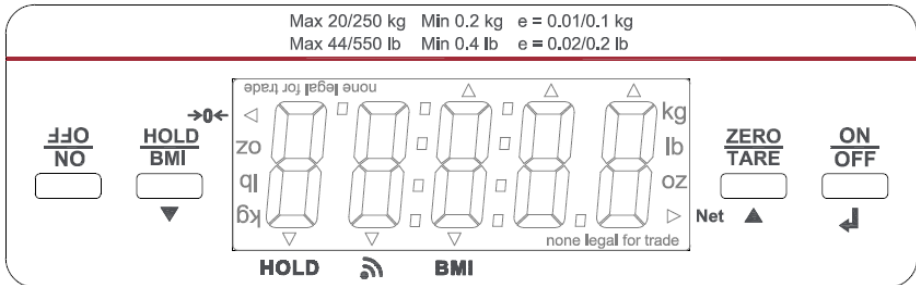

Key Function

1. **ON/OFF**(reverse): Power button. Weighing results will face patient when device is initially powered on.
2. **HOLD/BMI**: Press once to Hold (determine stable weighing value - used when weight is unstable). Press and hold for 3 seconds to enter Body Mass Index (BMI) calculation mode.
3. **ZERO/TARE**: Press to Zero or Tare weight. Press and hold for 3 seconds to enter settings.
4. **ON/OFF**: Power button. Weighing results will face operator when device is initially powered on. Use as "Enter" key for BMI input.
5. **UNIT**: (switch on bottom of device) switch between metric/imperial.

B. Display layout

1. : Weight is stable
2. : Weight is negative
3. : Device is at zero
4. : Wireless transmission (optional)
5. HOLD: Hold function is active
6. BMI: BMI function is active
7. Net: Current result is net weight

IV. Using Device

A. Basic Operation

Switch on the device using **[ON/OFF]** key. The direction of the display is determined by which **[ON/OFF]** key pressed. (To turn off device, press and hold **[ON/OFF]** key for 3 seconds) The device will automatically perform self-calibration, displaying software version.

Once "0.00 kg" appears on indicator, device is ready for measurement.

Note: If "0.00 kg" does not display on indicator, press **[ZERO/TARE]** key to zero the device. This function can be used for weight within $\pm 2\%$ of full capacity.

Guide subject to stand on device. After the weight has stabilized, the "stable" symbol will appear on indicator.

Note: If subject's weight exceeds scale capacity (including tare), indicator will display "Err" prompt due to overload.

B. Hold

The hold function determines average weight, designed to be used if subject's weight will not stabilize (ex: an active child).

Note: if fluctuation is too severe, average weight determination will be difficult and hold may not function correctly

1. Switch on the device normally.
2. Press the **[HOLD/BMI]** key. "HOLD" will be displayed on the indicator.
3. Guide subject to stand on device.
4. After a few seconds, the average weight will be displayed on the indicator. This weight will be locked - at this point, subject can leave measurement platform.
5. To release the locked weight, press the **[HOLD/BMI]** key again to return to the device to normal mode. (arrow next to "HOLD" on indicator will disappear)

Note: Hold function can be activated before or after subject stands on device. However, if subject finds it difficult to stand still, we recommend activating Hold after subject stands on device. Hold function will not function under 2 kg.

C. Tare

The tare function allows the user to deduct the weight of objects from the device's measurement result.

1. Place object that needs to be tared onto measurement platform.
2. Press **[ZERO/TARE]** key after stable symbol appears on indicator. Display will indicate "0.00 kg".
3. Guide subject (plus tared object) to stand on device. Conduct measurement.
4. To clear tare value, remove all objects from measurement platform, and press **[ZERO/TARE]** key.

D. Body Mass Index (BMI)

1. In normal mode, press and hold the **[HOLD/BMI]** key for 3 seconds to enter BMI mode.
2. Display will show last input height. Left-most digit will flash. (accepted range: 50-210cm / 2-7ft)
3. Adjust height value using **[TARE]** (increase ↑) and **[HOLD/BMI]** (decrease ↓) keys. (press and hold to speed up)
4. Press **[ON/OFF]** key to confirm height.
5. Proceed to weigh subject as usual. Indicator will display weight and BMI after measurement.
6. Press **[HOLD/BMI]** to return to normal mode.

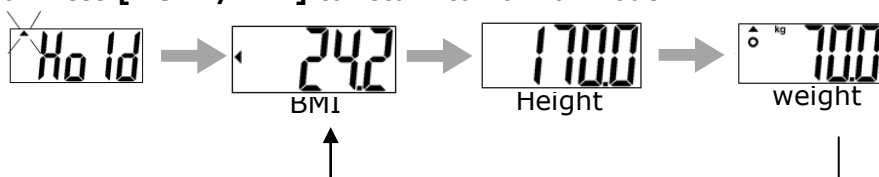

Category	BMI (kg/m ²)	Risk of obesity-related disease
Under	< 18.5	Low
Normal	18.5-24.9	Average
Over	24.9-29.9	Slightly Increased
Obese I	30.0-34.9	Increased
Obese II	35.0-39.9	High
Obese III	> 40	Very High

(World Health Organization adult BMI standards)

V. Device Setup

When the device is switched on, press and hold the **[ZERO/TARE]** key for 6 seconds, until the display shows the "SETUP", followed by "A_OFF" (first option in setting menu).

In device setup:

[HOLD/BMI] select menu option

[ZERO/TARE] confirm selection



Auto-off: Instruct device to shut off automatically after a certain period of time.

Auto off options: 60 sec / 120 sec / 180 sec / 240 sec / 300 sec / off

Press **[HOLD/BMI]** to toggle between time options, and **[ZERO/TARE]** to confirm selection.



Adapter Auto-Off: Select whether auto-off will be activated when device is plugged into adapter.

Press **[HOLD/BMI]** to toggle between ON/OFF, and **[ZERO/TARE]** to confirm selection.



Bluetooth (optional): If device has Bluetooth module installed, Bluetooth function can be turned on or off.

Press **[HOLD/BMI]** to toggle between ON/OFF, and **[ZERO/TARE]** to confirm selection.

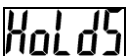

Hold Stop: When Hold Stop is "on", Hold will deactivate after subject leaves measurement platform.

Press **[HOLD/BMI]** to toggle between time options, and **[ZERO/TARE]** to confirm selection.



Date Setting: press [**ZERO/TARE**] to increase. Press [**HOLD/BMI**] to move to next digit. Press [**ON/OFF**] to confirm setting and move to next input. (e.g. after inputting Year, press [**ON/OFF**] to input month).

Order is YYYY.MM.DD.HH.DD (Year, Month, Day, Hour, Minute) (24 hour format).

VI. Wireless Connection

If the device has the wireless module installed, the indicator can transmit measurement results wirelessly. Please see Charder wireless software instructions for details.

VII. Troubleshooting

Before contacting your local Charder distributor for repair service, we recommend considering the following troubleshooting procedures:

Self-inspection

1. Device will not power on

- If battery power is depleted, replace with new batteries
- If batteries are not used, check if the AC power adapter is plugged into the device properly. Check if power adapter is plugged into mains properly

2. Measurement inaccuracy

- Interference due to factors such as RF disturbance or ground vibration. Relocate device to location without interference and try again
- External objects interfering with measurement platform. Clear platform of objects and try again
- Device may not function properly on soft surfaces such as carpets or lawns. Relocate device to location with solid, stable floor
- If the steps above cannot resolve the problem, re-calibration may be required to correct weighing accuracy

Distributor support required

If the following errors occur, we recommend contacting your local Charder distributor for repair or replacement services:



1. Device will not power on

- Faulty on/off key
- Broken or damaged wires causing short circuit or faulty connection
- Safety fuse burnout
- Faulty AC Adapter

2. Indicator damage

- Possible hardware defects include: uneven brightness in LCD screen, blurred text, smeared rainbow screen, incorrect decimal display
- Unable to save or read data
- Indicator shows "ERRL" after device is switched on
- Keys not responding
- Buzzer malfunction

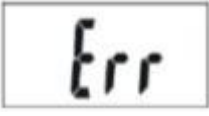
Error Messages

Error Message	Reason	Action
	Low battery warning Voltage of battery is too low to operate device	Replace batteries, or plug in adapter
	Overload Total load exceeds device's maximum capacity	Reduce weight on measurement platform and try again
	Zero count over calibration zero range +10% while power on	If problem persists, re-calibration required. Please contact distributor
	Zero count under calibration zero range -10% while power on	If problem persists, re-calibration required. Please contact distributor

VIII. Product Specifications

Model		MS6111
Weight Measurement	Capacity	0-20 kg x 0.01 kg 20-250 kg x 0.1 kg
	Accuracy	±2e
	Unit	kg/lb
	LCD Screen	1.0-inch LCD screen (5 digits)
Dimensions	Overall	345(W) x 350(D) x 45(H) mm
Device Weight		2.5 kg
Key Functions		On/Off, Tare, Hold/BMI
Data Transmission		Wireless module (optional) NOTE: Device should be connected to network by qualified distributors only
Power Supply		4 AA batteries / Power adapter
Operation Temperature & Humidity		5°C~35°C 15% / 85% RH
Standard Accessories		User manual x1, Power Adapter x1
Optional Accessories		Thermal Printer, Height Stadiometer, Carrying Bag



Warning

The device is only compatible with the power adapters specified below.

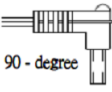
AMP VOLTAGE	DRAWING NO.	CE APPROVED TYPE NO. / MODEL NO.	TYPE	Adapter plug
12V 1A	AD-8095	UE24WCP1-120100SPA	US	 90 - degree
			EU	
			UK	
			AU	

IX. Declaration of Conformity

This product has been manufactured in accordance with the harmonized European standards, following the provisions of the below stated directives:

	93/42/EEC as amended by 2007/47/EC Medical Device Directive
--	--

Please see separate document showing on sticker of device for above CE marking.

Authorized EU Representative:



Obelis s.a.

Bd Général Wahis, 53
B-1030 Brussels
Belgium



Manufactured by:
Charder Electronic Co., Ltd.
No.103, Guozhong Rd., Dali Dist.,
Taichung City, 41262 Taiwan (R.O.C.)

CD-IN-1199 11172Q 04/2021